

REGULATIONS OF BRAZOS COUNTY, TEXAS, FOR THE CONSTRUCTION OF DRIVEWAYS AND CULVERTS IN COUNTY EASEMENTS AND RIGHTS OF WAY

SECTION 1 – AUTHORITY

The Commissioners Court has the authority to regulate subdivisions pursuant to Texas Local Government Code §232 and the obligation to protect the public health, safety and welfare of the citizens of Brazos County.

These regulations are adopted by the Commissioners' Court of BRAZOS County, Texas, in an effort to provide a safe environment on the county roadways. Structures built and work performed in the county rights-of-way and/or easements must be accomplished in a manner that is safe for the traveling public. Work performed shall meet at least the minimum standards outlined in this document.

SECTION 2 – SUMMARY OF THE REGULATION

The area between a private property line and the private property line across the road is called the County Right of Way. Because the Right of Way is Brazos County property, a driveway, sidewalk, mailbox or any other structure built or located within that Right of Way is a trespass and will require county permitting before beginning construction.

Situations where permits are required:

- New residential or commercial driveway and/or sidewalk construction;
- New residential or commercial culvert placement;
- New residential or commercial mailbox placement;
- Extension of existing culverts;
- Widening of existing driveways;
- Replacement of driveway, sidewalk, mailbox or culvert, and;
- Repair of existing driveways.

Brazos County requires a completed driveway/culvert permit application and an accurate site plan, including a legal description, prior to a request for a permit.

Mailbox requirements:

- The placement and construction of individual mailboxes will be strictly enforced because of the danger posed to citizens from the placement of mailboxes too close to the driving surface. Any proposed subdivision consisting of six or more lots of one (1)

acre or less in size shall utilize a cluster box system for mail. The County allows brick or other masonry mailboxes only if they are placed a minimum of five (5) feet from the driving surface. Furthermore, the County maintains the authority and discretion to remove, or require to be moved, any mailbox it deems to be unsafe.

Applicant shall hold harmless the County of Brazos and its duly appointed agents and employees against any action for personal injury or property damage sustained by reason of the exercise of this permit.

Applicant shall not erect any sign on or extending over any portion of the county road right of way.

Brazos County reserves the right to require the land/property owner to make any changes, maintenance or repairs as may be necessary to provide protection of life of property on or adjacent to the roadway. Changes in design will be made only with approval of the County Engineer/designee of Brazos County, Texas.

Brazos County reserves the right to remove any improvements or obstructions in county(s) right of way should the applicant fail to comply with the aforementioned requirements.

SECTION 3 – GENERAL PROVISIONS

- A. Construction of driveways on roadways with open ditch sections, culverts, median openings or modifications to the median whenever applicable, or the replacement, repair, or extension of existing driveways, culverts or median openings on County or public easements or right of way without first securing a permit is prohibited.
- B. Applications for permits for the construction of single family residential on roadways with open ditch sections, or agricultural driveways, culverts, median openings or modifications to the median whenever applicable, or the replacement, repair, or extension of existing driveways, culverts or median openings on County or public easements or right of way shall be made to the Brazos County Road and Bridge Department, 2617 State Highway 21 West, Bryan, TX 77803, Phone 979-822-2127 ext. 3024.
- C. Applications for permits for the construction of multifamily or commercial driveways, culverts, median openings or modifications to the median whenever applicable, or the replacement, repair, or extension of existing driveways, culverts or median openings on County or public easements or right of way shall be made to the Brazos County Engineer, 2617 State Highway 21 West, Bryan, TX 77803, Phone 979-822-2127 ext. 3033
- D. All permits issued by County Engineer or Road and Bridge Department for the construction of driveways, culverts or modifications on a County or public easement or right of way shall require conformance with these Requirements including Brazos County Engineering Department Guidelines and any subsequent amendments or revisions thereto.

- E. The County Engineer and Road and Bridge shall promulgate forms to be used in the administration of these Requirements.
- F. Permits shall provide that construction pursuant to the permit will be commenced within six months and be completed within nine months from the date of the permit and that fees collected for said permits shall not be refundable or transferable.
- G. Permits for the installation of driveways, culverts, or median openings or modifications must be obtained from the County Engineer or Road and Bridge prior to the start of construction.
- H. All permits which require a bond must be approved by Brazos County Commissioners Court.
- I. Brazos County Road & Bridge Department does not provide service for installation of culverts.

SECTION 4 – PERMIT SUBMITTAL REQUIREMENTS

- A. Single Family Residential and Agricultural Driveways (Open Ditch Sections) BRAZOS COUNTY RIGHT OF WAY ACCESS PERMIT APPLICATION
 - 1. When an application for a driveway with or without a culvert is filed, the applicant will provide the County Road and Bridge Department with the following information:
 - a. Street Address (Brazos County 9-1-1 provided address).
 - b. The proposed location of the driveway, and culvert whenever applicable, within the County or public easement and right of way. The locations shall be referenced to a lot line or property corner.
 - c. The location of physical objects such as drainage inlets or catch basin within the portion of the driveway which is the County or public easement or right of way that might conflict with the construction of the driveway. The applicant must provide the location of all man-made objects within the portion of the driveway which is within the County or public easement or right of way.
 - d. Whether a special design is required whenever driveways may be proposed in a location hazardous to traffic safety.
 - f. The length of the proposed culvert based on the following standards:
 - (1) Minimum for walkway: 8 feet
 - (2) Minimum for driveway: 24 feet
 - (3) Maximum for driveway: 40 feet
 - e. Prior to permit application submittal, Permittee shall contact Brazos County Road & Bridge Department at 979-822-2127 to verify pipe size diameter.
 - f. Minimum pipe size shall be 15” unless special conditions exist that may warrant a smaller size.

- g. The maximum pipe size for a driveway crossed shall not exceed a single row of 36" diameter pipe. Any driveway culvert requiring a larger pipe size shall be designed by a licensed Texas Engineer and constructed by a general contractor in order to obtain a permit.
 - h. Culverts will be placed a minimum of ten (10) feet from the property line.
2. The permit applicant will be responsible for cost of the pipe material, pipe fittings, safety ends, and other required accessories/material including delivery and off loading at the driveway site, and applicant will also provide all labor, materials and equipment to install the pipe including excavation, grading, and backfill between the adjacent road surface and the property line or right of way line.
 3. Horseshoe or multiple driveways on a tract of land may be permissible, depending on existing conditions. A separate permit must be obtained for each installation.
 - a. The maximum number of driveways allowed on a tract of land:

<u>Parcel Frontage Length</u>	<u>Number of Driveways</u>
Less than 105 ft.	1
105 ft. to 210 ft.	2
Greater than 210 ft.	3

B. Commercial (or Energy) Driveways – BRAZOS COUNTY RIGHT OF WAY ACCESS PERMIT

1. When an application for a driveway with or without a culvert is filed, the applicant will provide the following information.
 - a. The location of the driveway, and culvert whenever applicable, within the County or public easement and right of way. The locations shall be referenced to a lot line or property corner.
 - b. The location of physical objects such as drainage inlets or catch basin within the portion of the driveway which is the County or public easement or right of way that might conflict with the construction of the driveway. The applicant must provide the location of all man-made objects within the portion of the driveway which is within the County or public easement or right of way.
 - c. Whether a special design is required whenever driveways may be proposed in a location hazardous to traffic safety.
 - d. The length of the proposed culvert is based on the following standards:
 - (1) Minimum for driveway: 24 feet
 - (2) Maximum for driveway: 60 feet
 - (3) Inlets shall be spaced 50 feet or in the mid-point of any culvert over 50 feet in length
 - e. Commercial driveways shall be spaced with a minimum of fifty feet (50') separation. On major thoroughfares (arterials and collectors), driveways shall be placed with a minimum of one hundred fifty feet (150') separation.
 - f. Commercial driveways on arterial roadways shall be placed no closer than one hundred and fifty feet (150') from the ultimate curb line of an intersecting arterial or collector street. Commercial driveways on local streets are to be placed no closer

than seventy-five feet (75') from the ultimate curb line of an intersecting arterial. Commercial driveways on arterials are to be placed no closer than seventy-five feet (75') from the ultimate curb line of an intersection of a collector or local street.

- g. Commercial tract with ninety-five (95') or less frontage on a public street shall have no more than one (1) driveway. Commercial tract with between three hundred twenty feet (320') and ninety-six (96') frontage on a public street shall have no more than two (2) driveways. Commercial tract with between six hundred feet (600') and three hundred twenty-one feet (321') frontage on a public street shall have no more than three (3) driveways.
- h. Every permit application must be accompanied by a complete set of construction details and specification to fully convey the work to be performed in the County right of way and to assure conformance with these Requirements including Brazos County Engineering Department Construction Standards and Details and any subsequent amendments or revisions thereto.
- i. All cost for materials, labor, and equipment shall be paid by the applicant.
- j. All work shall be done by a responsible, qualified contractor.
- k. Temporary drainage pipes (180 days or less) are exempt from this regulation provided a permit is obtained for working within the Brazos County right of way.

SECTION 5 – CONSTRUCTION & INSPECTIONS

- A. Driveways connecting to concrete curb and gutter roadways shall be inspected after the placement of reinforcing steel and prior to the pouring of concrete, and again after the concrete pour for conformance with County standards.
- B. Driveways connecting to asphalt roadways will be inspected after the placement of materials for conformance with plans.
- C. The installation of culverts shall be governed by the following procedures:
 - 1. Culverts shall not be set until flow line elevations are set and approved by Brazos County.
 - 2. Culverts shall not be backfilled until an inspection is conducted by Brazos County to determine that the elevation and grade of the culverts have been correctly set.
 - 3. Culverts shall also be inspected upon completion of the placement of cement stabilized backfill, if required, and prior to commencement of driveway construction.
- D. All driveways requiring special geometric design shall be inspected for conformance with plans.
- E. The County Engineer may make any additional inspections deemed necessary to administer these Regulations.

- F. Sidewalks will be inspected before placement of concrete while formwork and re-bar are exposed. Inspection will verify nominal thickness of concrete. Items inspected will cover location, slope and obstruction by improperly elevated manholes, water valves etc.

SECTION 6 – ENFORCEMENT

The County Engineer shall be charged with the enforcement of these Regulations. If any person violates any provision of these Regulations the County Engineer will attempt to obtain compliance with these Regulations.

Driveways that have been installed without notification or authorization (unpermitted) by the County and have been found to hinder drainage or violate one of the above regulations will be removed and placed on the adjacent offending property following the process noted below:

- A. A Notice of Violation (NOV) will be placed on a stake or fence post to notify the property owner or installer that a violation has been identified by the County. The NOV provides the property owner with basic information regarding the cause for violation and provides contact information for the County Engineer or his representative.
- B. If no response is received within the ten (10) day period provided on the NOV then a letter will be mailed to the property owner noting the cause for violation along with the contact information for the County Engineer or his representative.
- C. If any person engages in the construction of a driveway, sidewalk or culvert crossing a County easement or right-of-way without a permit, the Commissioners' Court may direct the County Attorney to file suit to enjoin the violation of these Regulations.
- D. If any person engages in the construction of a driveway, sidewalk or culvert crossing a County easement or right-of-way without a permit, or if any person engages in the construction of a driveway or culvert in any manner except as specified in the permit issued therefore by the County Engineer, the Commissioners' Court may order the landowner to remove or repair the driveway or culvert at the landowner's expense.

[Texas Local Government Code §81.025, 1987]

When regulating driveway installations wherein a permit has been issued but the installer (property owner or contractor) has failed to:

- 1. start construction within the six (6) month period allowed;
- 2. correct the element that failed an inspection; or
- 3. complete construction within the nine (9) month period allowed;

the County Engineer may so report to the Commissioners' Court and the following remedies may be pursued:

1. If any person engages in the construction of a driveway, sidewalk or culvert in any manner except as specified in the permit issued therefore by the County Engineer, the Commissioners' Court may direct the County Attorney to file suit to enjoin the violation of these Regulations.
2. Any person securing a permit under these Regulations must certify to Commissioners' Court that the terms, provisions and conditions of the permit will be complied with. Violation of this certification constitutes contempt of Commissioners' Court.
3. If the Commissioners' Court finds a person to be guilty of contempt, it may enter such orders consistent with general law as it deems appropriate to punish the person guilty of contempt, and may enter such order and further orders enforceable by civil and criminal contempt, and consistent with its authority under general law, as Commissioners' Court deems necessary to enforce and protect its jurisdiction over the matter and to uphold the integrity of these Regulations.
4. The procedure for contempt proceedings before Commissioners' Court will be consistent with procedures in actions before other courts in this state for enforcement of court orders, and for the protection of the jurisdiction of courts by process of contempt. Provided, however, that the person shall be given ten (10) days notice of said contempt proceeding by certified or registered mail, return receipt requested.

SECTION 7 – EXCEPTIONS

- A. Appeals for exceptions to these Requirements will be considered on the following basis and only after good and sufficient cause has been demonstrated by the applicant for an exception:
 1. Upon denial of permit, the applicant may appeal the County Engineer's decision by stating and submitting his reasons in writing to the County Engineer within ten (10) days of the denial of said permit.
 2. The County Engineer shall review the appeal and within fifteen (15) days of receipt of the said appeal, shall reduce his findings to writing and submit his findings and recommendation to Commissioners' Court. The applicant shall be provided with a copy of the County Engineer's recommendations and may appear before Commissioners' Court to support his appeal.

SECTION 8 – RECORDS

- A. All applications and file copies of permits issued pursuant to these Requirements shall be maintained by the County Engineer or Road & Bridge as part of the permanent records of his office.

SECTION 9 – EFFECTIVE DATE

- A. The requirements shall become effective upon approval of Commissioners Court.

SECTION 10 – SEVERABILITY

- A. The provisions of these Requirements are severable. If any word, phrase, clause, sentence, section, provision, or part of these Requirements should be held invalid or unconstitutional, it shall not affect the validity of the remaining provisions, and it is hereby declared to be the intent of the Commissioners' Court that these Requirements would have been adopted as to the remaining portions, regardless of the invalidity of any part.

SECTION 11 – PERMIT FEES AND BONDS

NOTE: ALL PERMIT FEES ARE NON-REFUNDABLE and NON-TRANSFERABLE.

The fees for permits and inspections shall be as follows:

- A. PERMITS:
 - 1. Single Family Residential and Agricultural Driveways (Open Ditch Sections) - New and modify/add-ons.
 - a. Permit Fee: Payable at the time permit application is submitted.

SECTION 12 – APPLICATIONS

Applications for permits for the construction of driveways, sidewalks and culverts on County or public easements or rights-of-way shall be made to the County Engineer prior to the start of construction.

- A. Permits from the County are not required for the following:
 - 1. The *repairs* of driveways constructed on concrete curb and gutter public streets, or
 - 2. The installation, repair, or replacement of driveways / culverts on roads that are not in the County's Road and Bridge road maintenance system.
- B. When an application for a driveway, with or without a culvert or sidewalk, is filed, the applicant (property owner or installer) will provide and consider the

following:

1. The location of the driveway / culvert by staking its beginning and the end on the ground and showing the distance from the nearest property corner or intersecting street or road.
2. Whether the driveway / culvert will provide ultimate access to single family residential / agricultural or multi-family residential / commercial development.
3. The type of driveway surface and culvert material. All culverts shall be constructed of reinforced concrete or CMP (Polymer Coated CMP at concrete drives) or equivalent. All concrete pre-cast conduits or pipe shall be new, tongue and grove (bell ended pipe shall not be used), reinforced Class III pipe. An exception may be granted for the use of used reinforced concrete pipe for residential use only after an inspection of the pipe and the County Engineer determines that the quality of the used pipe is equivalent to new pipe.
4. The length of the proposed culvert based on the following standards:

	Single Family Residential / Agricultural	All Other Driveways
Minimum for walkway	One joint of pipe (8')	
Minimum for driveway	24 feet	24 feet
Maximum for driveway	40 feet	60 feet (<i>Inlets shall be spaced 50 feet or in the midpoint of any culvert over</i>)

New Street Crossings or Connections to Existing Streets: Length to be determined by the County Engineer.

5. The location of all physical objects such as drainage inlets or catch basins within the portion of the driveway or sidewalk which is within the County or public easement or right-of-way that might conflict with the construction of the driveway. The applicant must provide the location of all manmade objects within the portion of the driveway or sidewalk which is within the County or public easement or right-of-way.
6. That a driveway connecting to a concrete curb and gutter street or road is designed in accordance with Brazos County Drawings and any subsequent amendments or revisions thereto as promulgated by the County Engineer.
7. That a driveway constructed over a roadside ditch culvert conforms to at least the geometric requirements of the aforementioned drawings.

8. Safety end treatments with pipe runners are required for all pipes larger than 30”.
9. That driveways proposed to be located on a corner lot is not shown to be located within any portion of public street curb radii.
10. Whether a special design is required whenever the driveway may be proposed in a location hazardous to traffic safety.
11. That driveways located on the same property shall be separated by a minimum of twenty (20) feet.
12. That sidewalks constructed in County rights-of-way or easements be constructed in accordance with the Brazos County Drawings and any subsequent amendments or revisions thereto as promulgated by the County Engineer.
13. The size of culvert. The minimum culvert diameter shall be fifteen (15) inches.
14. Commercial sites shall be required to have their driveway designed by a professional engineer and submitted to the County Engineer for review.
15. Whether the proposed culvert conforms to all other requirements of these regulations.
16. If the County has need to increase the size or change the depth and grade of an existing roadside ditch or drainage easement, the County will incur the cost of the replacement for existing driveways within the work area. Driveways will be replaced with similar material. The driveway installation will only be offered to properties that exhibit signs of recent and frequent access or to properties that have existing structures such as garages or boat barns that require vehicular access.
17. The property owner will be responsible for the maintenance, upkeep, and repair of the culvert crossing (driveway surface and pipe opening).
18. Temporary culverts, culverts used for access to property used for agricultural purposes or for access to single family dwellings, are exempt from this requirement.

All permits issued by the County Engineer for the construction of driveways, sidewalks or culverts on a County or public easement or right-of-way shall require conformance with these Regulations including Brazos County Drawings and any subsequent amendments or revisions thereto as promulgated by the County Engineer.

The County Engineer shall promulgate forms to be used in the administration of these Regulations.

SECTION 13 – FEES

Per the Fee Schedule adopted by Commissioner’s Court approval, fees for driveway permits and re-inspections are as follows:

	New	Modification	Re-Inspection
Single Family Residential / Agricultural	\$100	\$50	\$50
Multi-Family Residential/ Commercial	\$100	\$50	\$100

SECTION 14 – PROMULGATION OF FORMS

Forms are promulgated for use in the administration of these regulations. The County Engineer may add to these forms or may promulgate additional forms as may be needed to administer these regulations.

SECTION 15 – PROMULGATION OF DETAILS

Details (drawings) are promulgated for use in the administration of these regulations. The County Engineer may revise these details or may promulgate additional details as may be needed to administer these regulations.

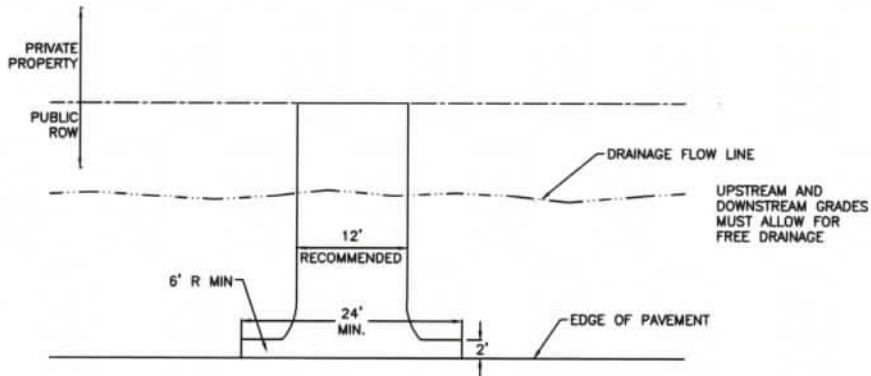

PLAN OF DRIVEWAY CONNECTION
ASPHALT

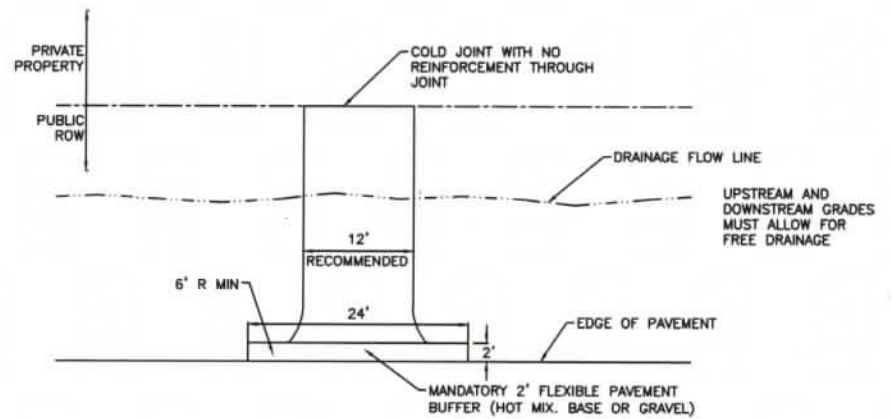

PLAN OF DRIVEWAY CONNECTION
CONCRETE

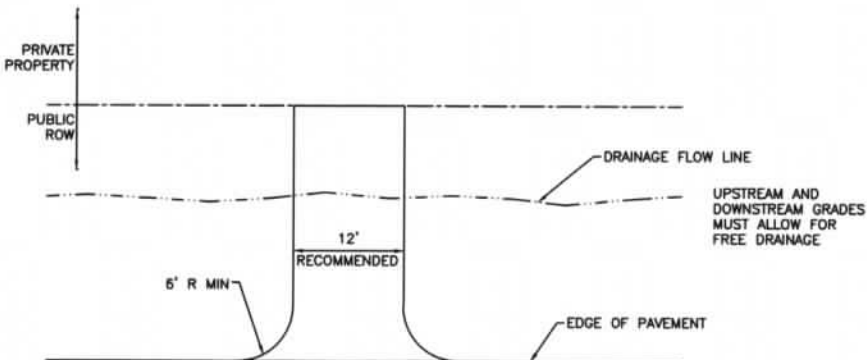

PLAN OF DRIVEWAY CONNECTION
GRAVEL OR BASE

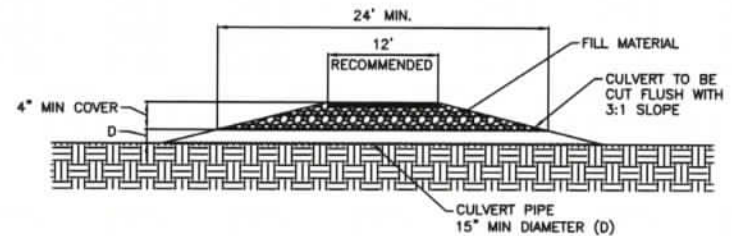

DRIVEWAY WITH CULVERT
CROSS SECTION

NOTES:

DRAINAGE SHALL BE ADDRESSED BY ONE OF THE THREE OPTIONS:

- 1) DIP
- 2) CONSTANT SLOPE
- 3) CULVERT

IT IS RECOMMENDED THAT A CULVERT TYPE DRIVEWAY BE USED ONLY WHEN EXTREME CONDITIONS PREVENT THE USE OF A DIP OR CONSTANT SLOPE FROM BEING FEASIBLE. CONSULT WITH BRAZOS COUNTY ENGINEER'S OFFICE FOR APPLICATION TO LOCAL CONDITIONS.

NO OTHER IMPROVEMENTS THAT PROJECT ABOVE EXISTING GRADE SHALL BE ALLOWED WITHIN THE COUNTY RIGHT OF WAY.

WATER MUST FLOW FREELY THROUGH CULVERT PIPE OR OVER DIP TYPE DRIVEWAY.

IT IS RECOMMENDED THAT THE CONTRACTOR CONTACT THE BRAZOS COUNTY ENGINEER'S OFFICE FOR A PRE-POUR INSPECTION PRIOR TO POURING CONCRETE OR PLACING HOT MIX ASPHALT.



BRAZOS COUNTY
ROAD AND BRIDGE DEPARTMENT
2617 W HWY 21
BRYAN, TX 77803
PHONE: (979) 822-2127
FAX: (979) 775-0453

RESIDENTIAL DRIVEWAY DETAIL
STANDARD

DATE: 10/20/2015

SCALE: NTS

DRAWN BY: PPB

REVISION: 1

CHECKED BY: RAM

SHEET: 1 OF 1

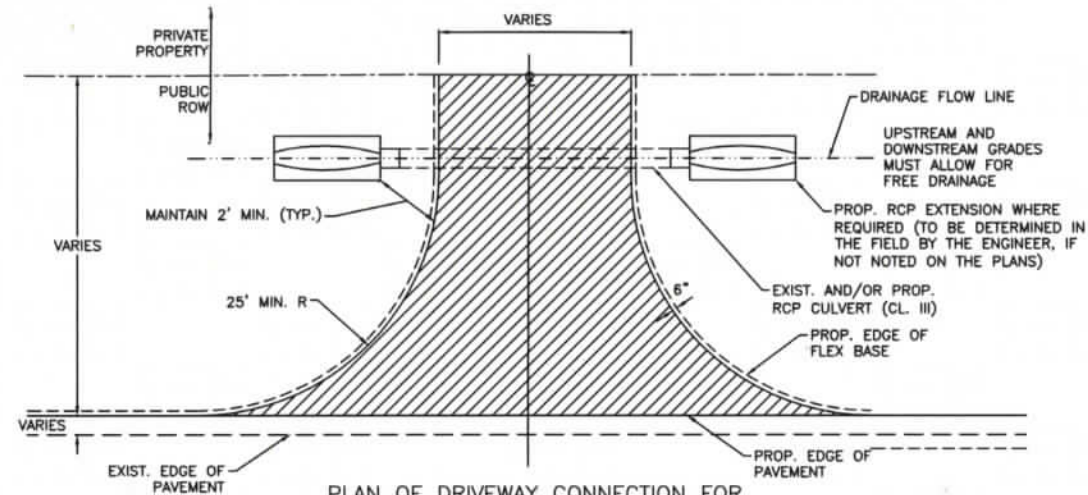

PLAN OF DRIVEWAY CONNECTION FOR PRIVATE AND COMMERCIAL DRIVES

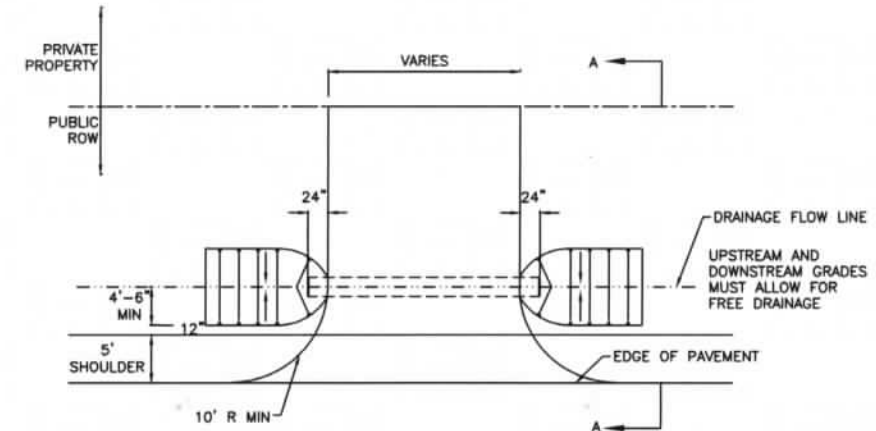

PLAN OF DRIVEWAY CONNECTION

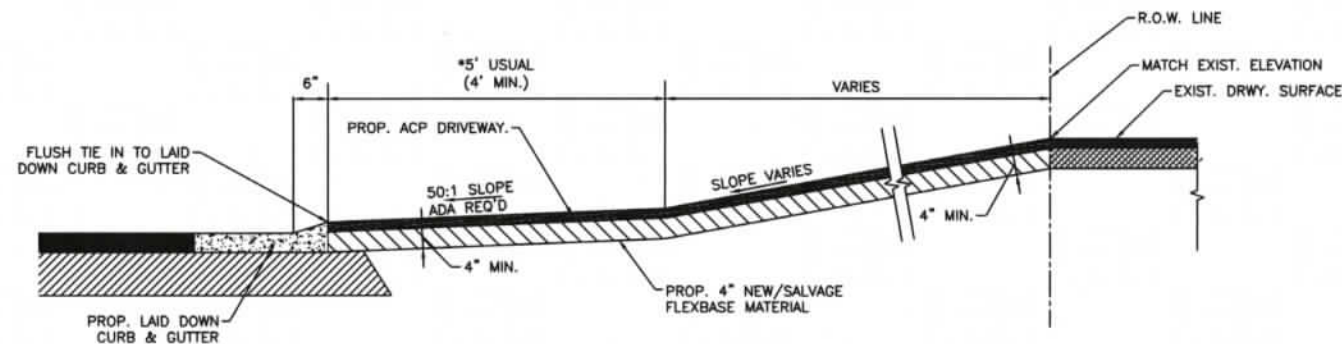

TYPICAL ASPHALT CONCRETE PAVEMENT DRIVEWAY SECTION

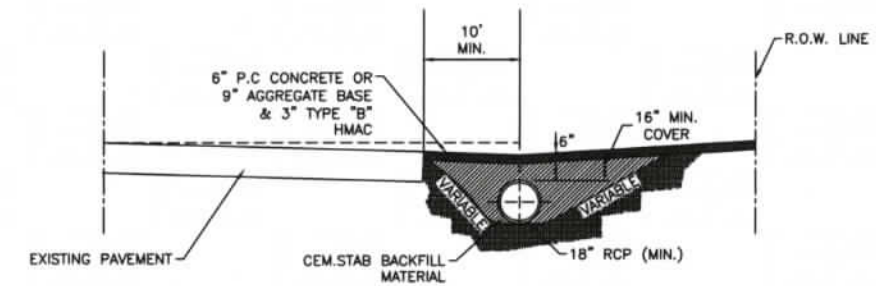

SECTION A-A

TEMPORARY DRIVEWAY DETAILS FOR OIL FIELD DEVELOPMENT ACCESS

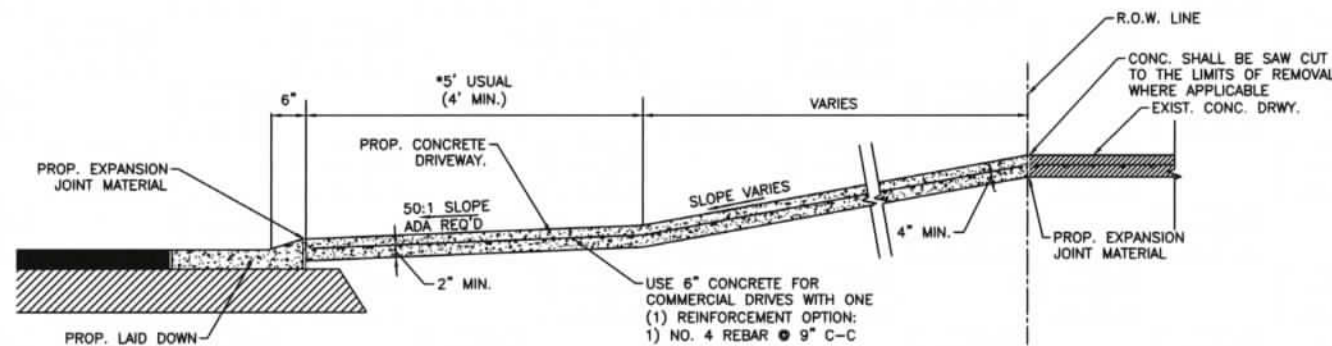

TYPICAL CONCRETE DRIVEWAY SECTION

USE 6" CONCRETE FOR COMMERCIAL DRIVES WITH ONE (1) REINFORCEMENT OPTION:
1) NO. 4 REBAR @ 9" C-C

* PROF./FUTURE SIDEWALK CROSSING LOCATION UNLESS SHOWN ELSEWHERE ON P&P SHEETS. SEE P&P SHEETS FOR PROF. SIDEWALK LOCATION IF SIDEWALKS ARE INCLUDED AS PART OF PROJECT. REFER TO STATE STANDARDS--PEDESTRIAN FACILITIES--FOR ADDITIONAL REQUIREMENTS.

NOTES:

1. EXIST. PRIVATE OR COMMERCIAL DRIVEWAYS TO BE CONSTRUCTED AS SHOWN WITH 4" NEW AND/OR SALVAGE FLEX BASE, PRIMED AND SURFACED WITH 114#/SY ACP.
2. EXIST. BUSINESS DRIVEWAYS TO BE CONSTRUCTED AS SHOWN WITH 6" CONCRETE. TO BE PAID FOR BY THE SQ. YD.
3. CLEAN AND SEAL ALL JOINTS AND SAW CUTS IN ACCORDANCE WITH STANDARD SPECIFICATIONS.
4. IF A GUTTER HOLDS WATER PRIOR TO ANY CONSTRUCTION BY DRIVEWAY CONTRACTOR, HE SHOULD NOTIFY THE COUNTY ENGINEER OF THE SITUATION BEFORE DOING ANY WORK. THE COMPLETED DRIVEWAY WORK WILL NOT BE ACCEPTED IF THE GUTTER HOLDS WATER DUE TO POOR CONSTRUCTION BY THE CONTRACTOR.
5. IT IS RECOGNIZED THAT THESE DRIVEWAYS DETAILS WILL NOT COVER EVERY POSSIBLE SITUATION ENCOUNTERED IN CONSTRUCTION. ADDITIONAL EXPANSION JOINTS WILL BE REQUIRED AS NEEDED.
6. ALL DRIVEWAYS OF THIS TYPE SHALL BE DESIGNED BY LICENSED CIVIL ENGINEER.
7. ALL CONDUIT MATERIALS SHALL BE RCP.



BRAZOS COUNTY
ROAD AND BRIDGE DEPARTMENT
2617 W HWY 21
BRYAN, TX 77803
PHONE: (979) 822-2127
FAX: (979) 775-0453

PRIVATE, COMMERCIAL AND TEMPORARY
OIL FIELD DEVELOPMENT DRIVEWAY
DETAIL STANDARDS

DATE: 10/20/2015

SCALE: NTS

DRAWN BY: PPB

REVISION: 1

CHECKED BY: RAM

SHEET: 1 OF 1